

Make a Crab outfit!

You will need ...

Orange/red sugar paper

White paper

Sellotape

Black pen

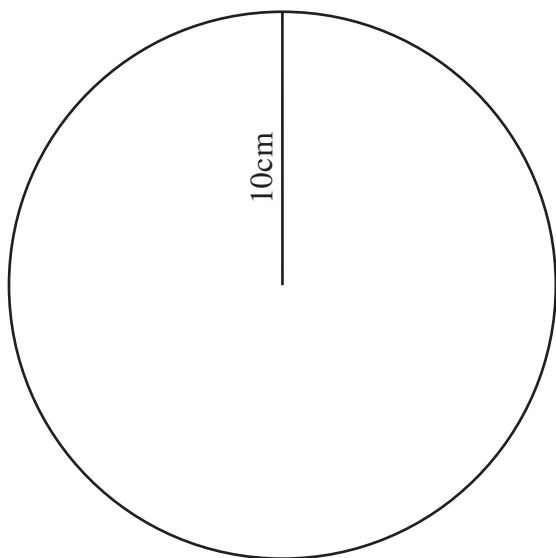

1) Cut a piece of orange/red paper in this shape (with a radius of 10cm). Cut down the line and roll it round to make a cone.

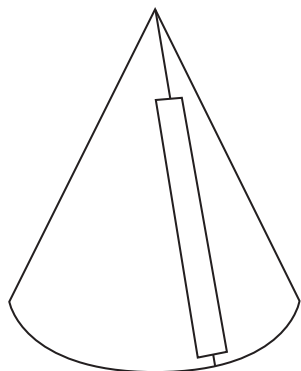

2) Tape along the seam to create the top section of your crab claw.

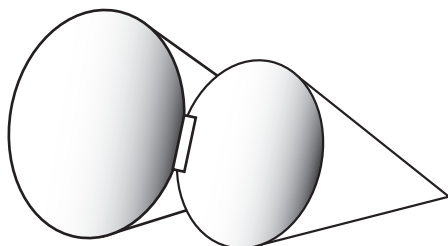

3) Repeat the process with a slightly smaller piece of paper to make the bottom section of the claw (radius of 8cm). Tape both of the cones together in the middle to make one of your claws.

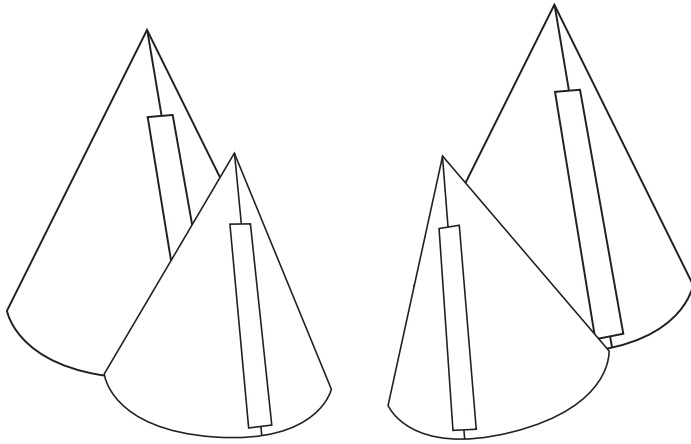

4) Repeat the whole process so that you've got two claws.

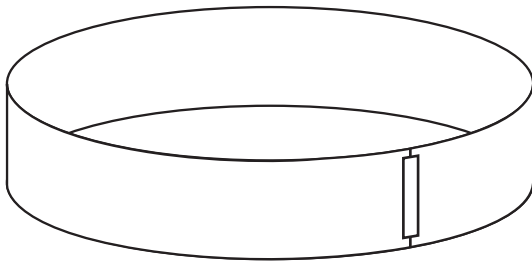

5) Cut a strip of orange/red paper and stick it so that it fits around your head.

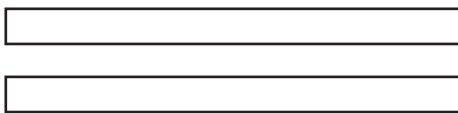
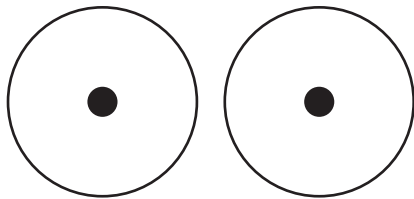

6) Cut two strips of orange/red paper about 14cms long and 1cm wide, and two eye shapes from white paper.

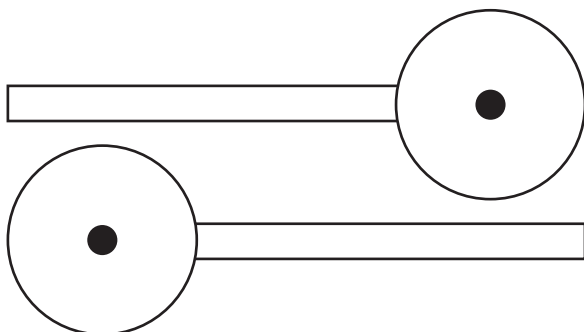

7) Tape the eyes to the ends of each strip.

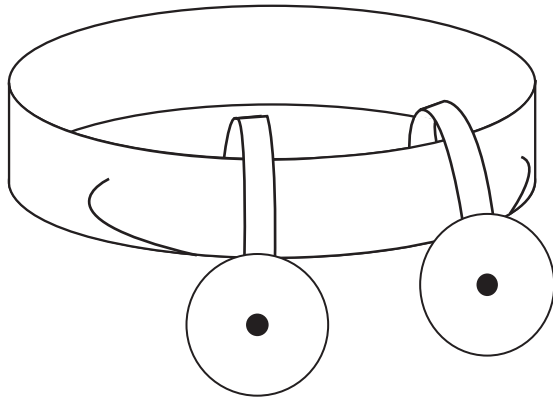

8) Tape the other ends of the strips to the inside of the loop. This will let the eyes bounce up and down. You can draw a smile on the loop too, to make it look like a face.

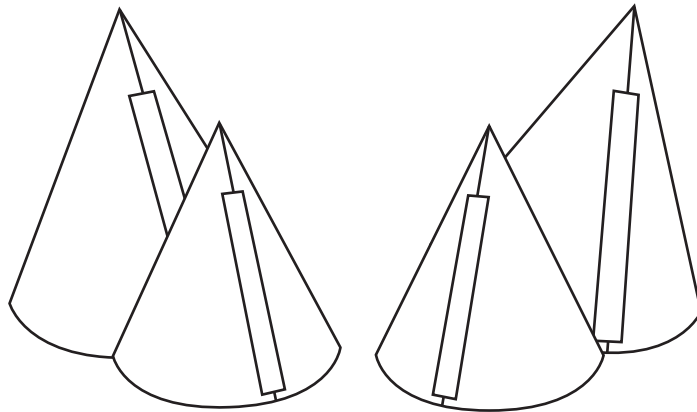

Make an Octopus outfit!

You will need ...

Adhesive for papier-maché (either wallpaper paste or diluted PVA glue)

Newspaper

A balloon

Paints

4 pairs of old tights

String/a belt

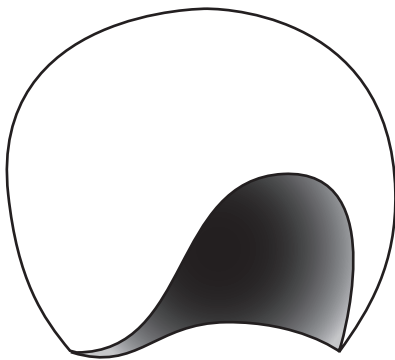
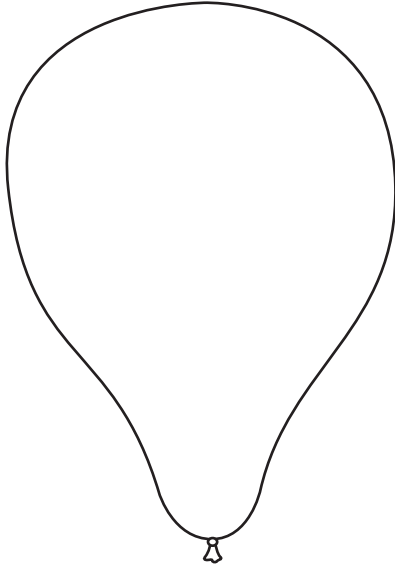

1) Blow up a normal shaped balloon, this is going to form the head of your octopus. Make a bowl full of papier-maché (enough to cover the balloon) and start to apply the strips of newspaper to the outside of it. The balloon will need 3 or 4 layers of papier-maché for strength, when you've done this, let it dry out for roughly 24 hours.

2) When the papier-maché is dry and hard, pop the balloon. You can paint the papier-maché whatever colour you think would suit your octopus best. Next, cut out the shape shown. This will be the head of your octopus - you'll wear it like a helmet, so the hole shouldn't be too big or too small.

3) Now paint 2 eyes and a smile onto your head.

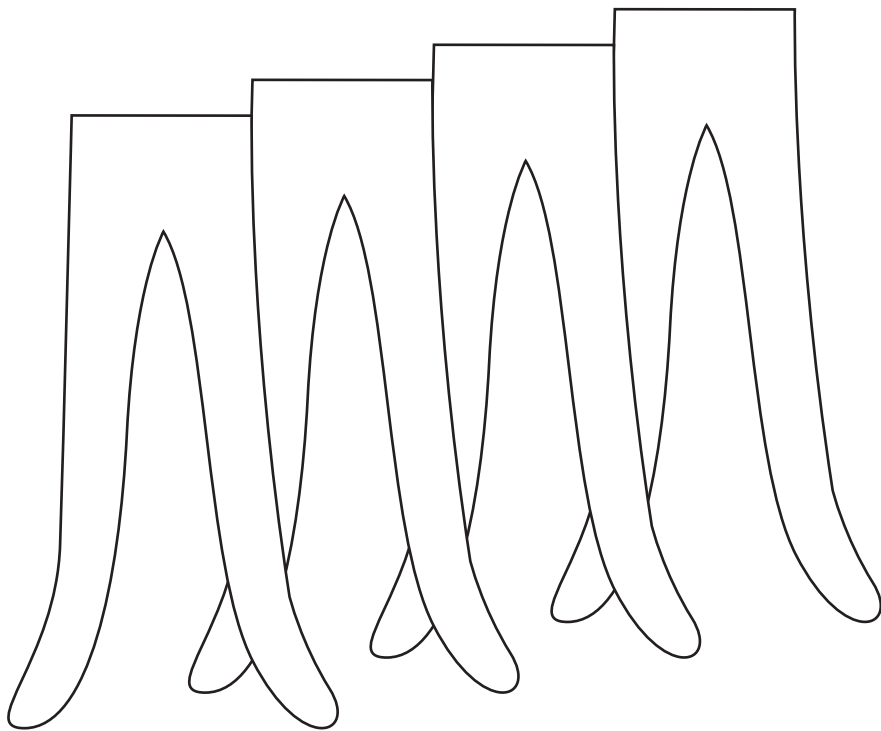

4) Next you need to make the octopus's eight legs. You'll need to get your hands on four pairs of old tights. Try and get them so they're the same colour as you painted the head. Stuff them all with screwed up old newspapers to the tops of the legs. If the tights don't match the colour of the head, you can paint them.

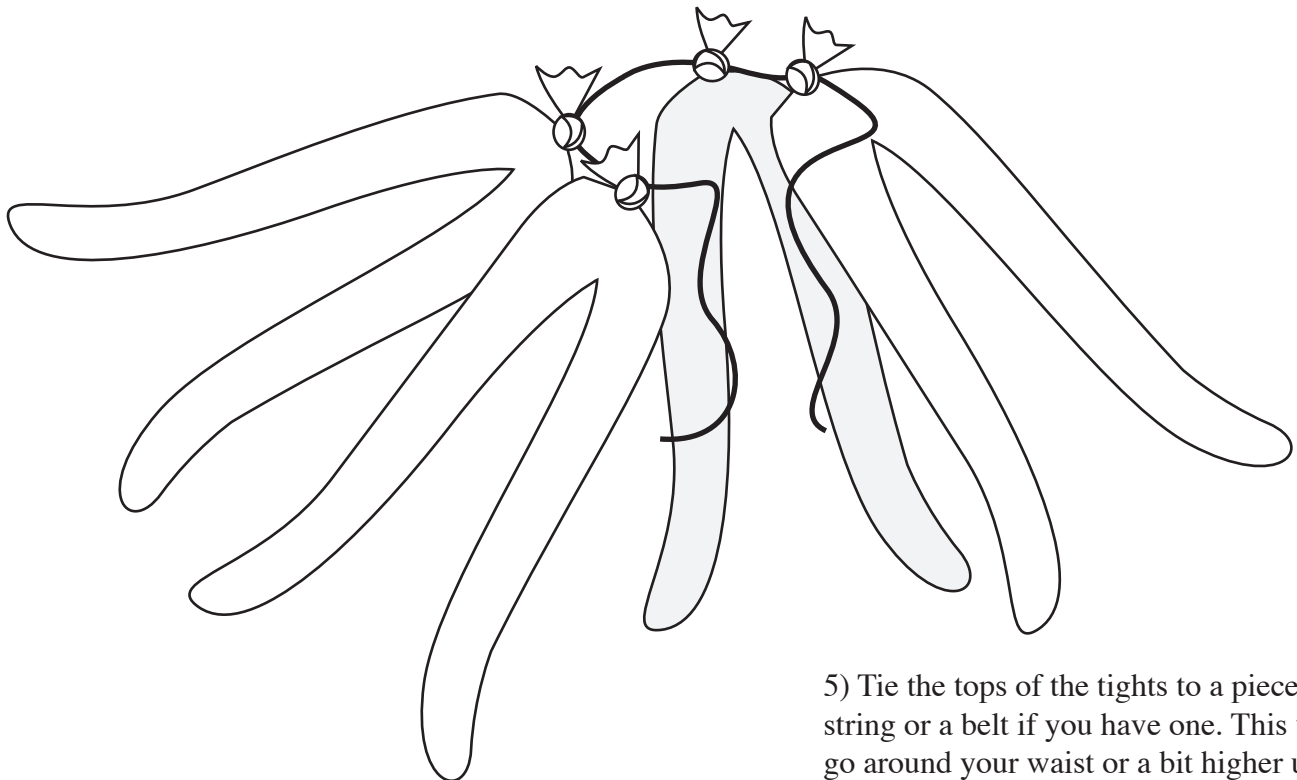

5) Tie the tops of the tights to a piece of string or a belt if you have one. This will go around your waist or a bit higher up and form your eight legs.

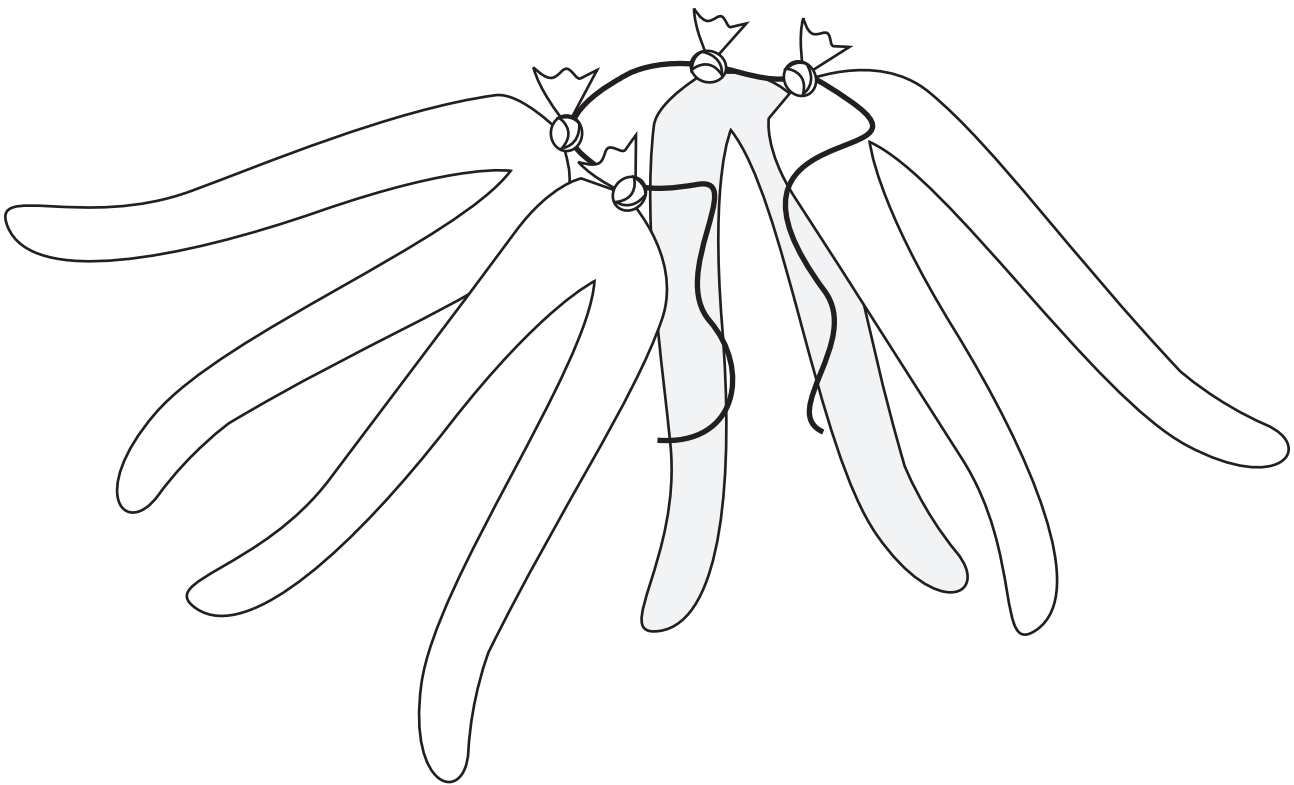

Make a Shark outfit!

You will need ...

2 x A3 pieces of blue/grey sugar paper

Glue

Sellotape

Paints

String

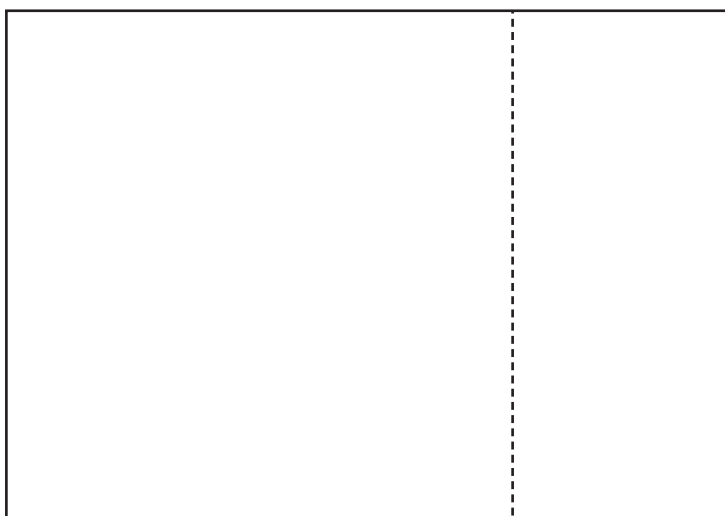

1) Cut a square from an A3 piece of paper and save the rectangle. This is going to be the head of your shark, so it should be blue or grey paper if possible.

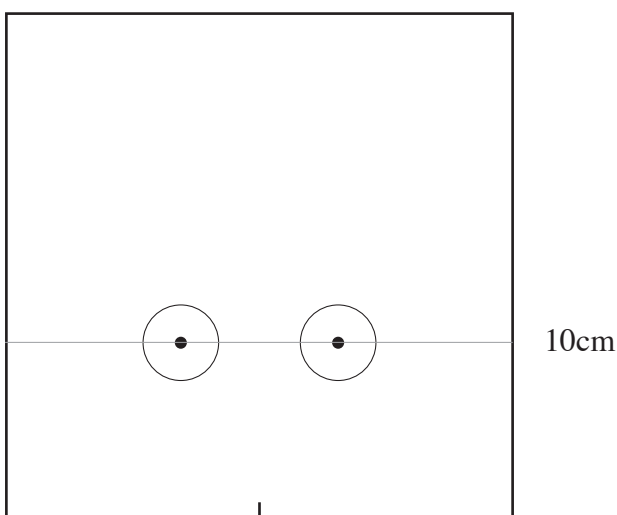

2) Find the mid-point on the bottom edge of the page and measure roughly 10cms up and draw two eyes.

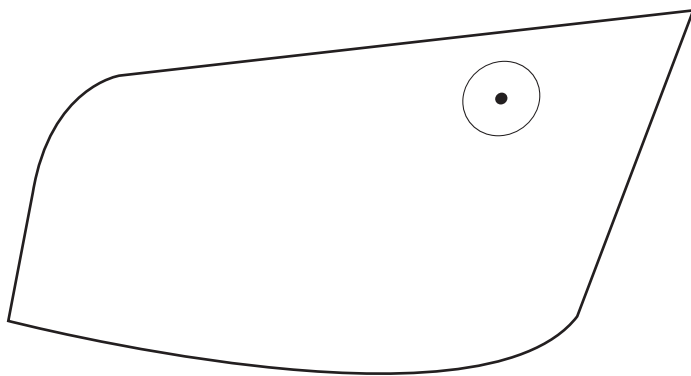

3) Roll the corners of the page towards each other around the mid-point to create a cone shape which will be the nose of your shark. You can use sellotape on the inside of the cone to hold it in place.

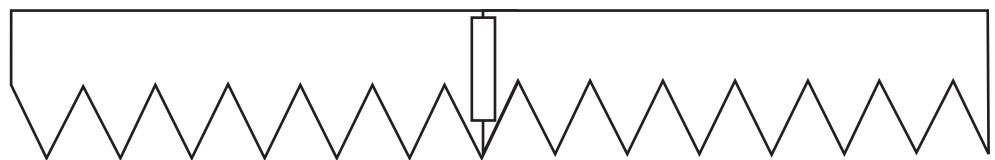
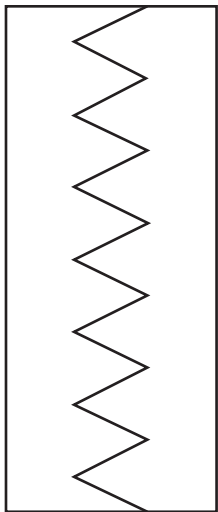

4) Cut out teeth shapes from the remaining piece of paper and join them together so that you have a long shape. Now you can paint the triangles white.

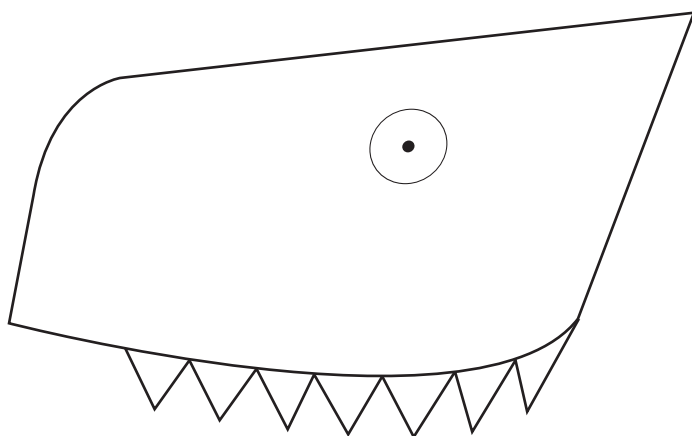

5) Glue the teeth to the inside of the head so you can see the white triangles, and then your head is finished.

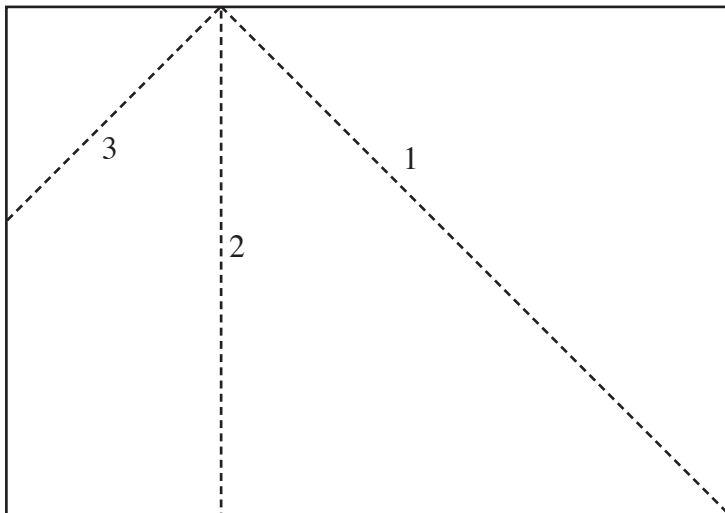

fold

6) Starting with number 1 make these folds on an A3 piece of paper that's the same colour as your shark head. When you've made all of these folds, lay the page out flat again.

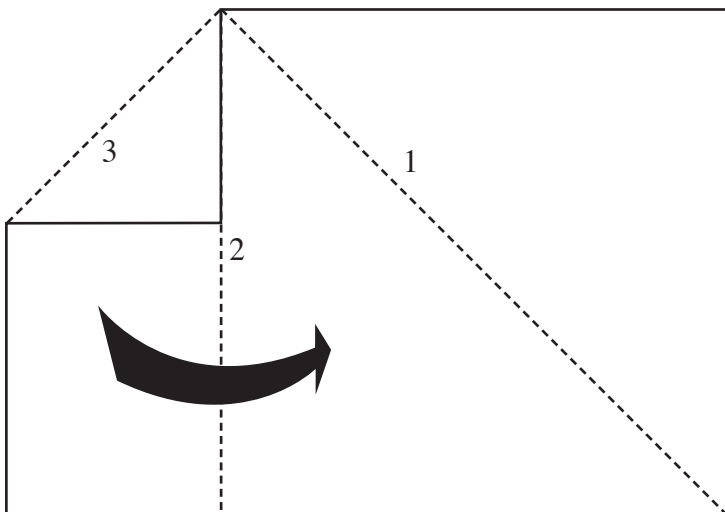

7) Now, fold over number 3 again, then fold over number 2 as shown. This will leave you with a square shape.

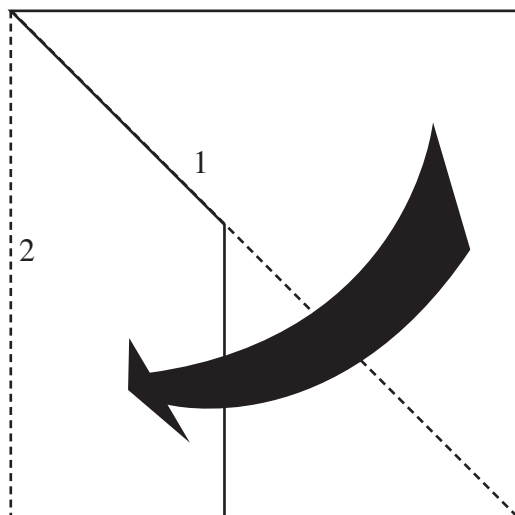

8) Once you have the square you can re-fold number 1 down to make the triangle shape of your dorsal fin.

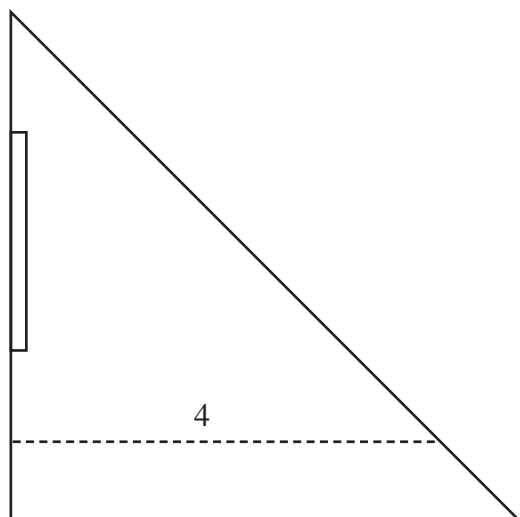

9) To be able to attach the fin to your back properly you need to make a 'foot' at the bottom of it first. Make another fold (number 4 in the diagram) 6cm from the bottom of the triangle. You can add a small strip of sellotape at the back to hold it all together properly.

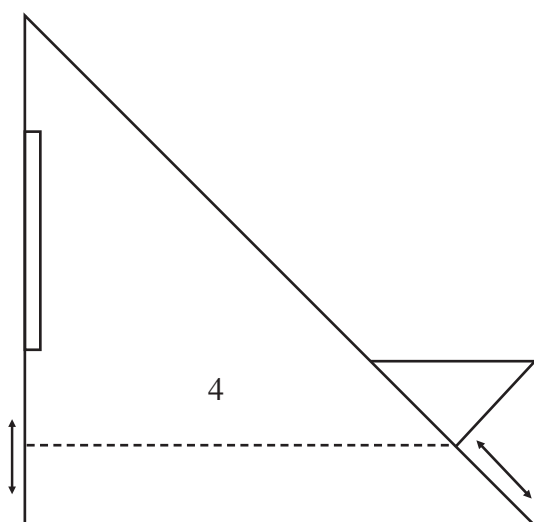

10) Now cut down from the fold to the bottom of the fin - indicated by the arrows. This forms the 'foot' which will help you attach it to your back.

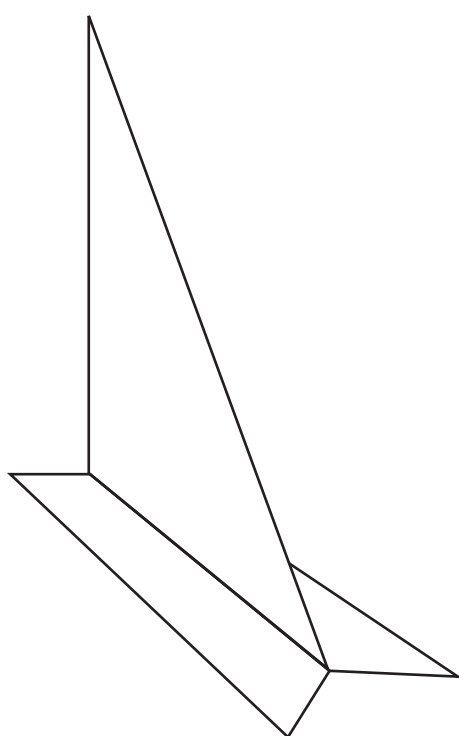

11) Your shark's fin should look like this. You've got one more thing to do, and then you're finished.

12) Cut down the middle of both sides of the foot up to the fold. Then stick this to a piece of cardboard, this will make it very strong.

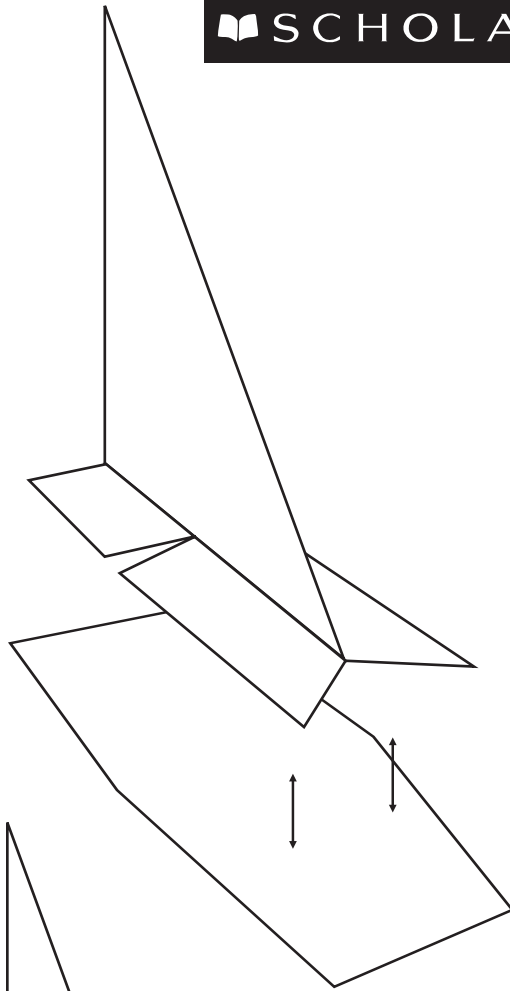

13) Make a hole either side of the fin and tie a piece of string to each one. Place the fin on your back and tie the string around your chest. Put the shark hat on your head, and you're ready to go!

